

**GaAIAs-IR-Lumineszenzdiode (880 nm)**  
**GaAIAs Infrared Emitter (880 nm)**  
**Lead (Pb) Free Product - RoHS Compliant**

**SFH 487 P**



**Wesentliche Merkmale**

- GaAIAs-LED mit sehr hohem Wirkungsgrad
- Hohe Zuverlässigkeit
- Hohe Impulsbelastbarkeit
- Gute spektrale Anpassung an Si-Fotoempfänger
- Gehäusegleich mit SFH 309

**Features**

- Very highly efficient GaAIAs-LED
- High reliability
- High pulse handling capability
- Good spectral match to silicon photodetectors
- Same package as SFH 309

**Anwendungen**

- IR-Fernsteuerung von Fernseh-, Rundfunk- und Videogeräten, Lichtdimmern
- Lichtschranken bis 500 kHz
- Münzzähler
- Sensorik
- Diskrete Optokoppler

**Applications**

- IR remote control for hifi and TV sets, video tape recorder, dimmers
- Light-reflection switches (max. 500 kHz)
- Coin counters
- Sensor technology
- Discrete optocouplers

Typ Type	Bestellnummer Ordering Code	Gehäuse Package
SFH 487 P	Q62703Q0517	3-mm-LED-Gehäuse, plan, klares violette Epoxy-Gießharz, Anschlüsse im 2.54-mm-Raster (1/10"), Anodenkennzeichnung: kürzerer Anschluß 3 mm LED package (T 1), plane, violet-colored transparent epoxy resin, solder tabs lead spacing 2.54 mm (1/10"), anode marking: short lead

**Grenzwerte** ( $T_A = 25\text{ °C}$ )**Maximum Ratings**

Bezeichnung Parameter	Symbol Symbol	Wert Value	Einheit Unit
Betriebs- und Lagertemperatur Operating and storage temperature range	$T_{op}; T_{stg}$	- 40 ... + 100	°C
Sperrspannung Reverse voltage	$V_R$	5	V
Durchlaßstrom Forward current	$I_F$	100	mA
Stoßstrom, $\tau \leq 10\ \mu\text{s}$ Surge current	$I_{FSM}$	2.5	A
Verlustleistung Power dissipation	$P_{tot}$	200	mW
Wärmewiderstand, freie Beinchenlänge max. 10 mm Thermal resistance, lead length between package bottom and PC-board max. 10 mm	$R_{thJA}$	375	K/W

**Kennwerte** ( $T_A = 25\text{ °C}$ )**Characteristics**

Bezeichnung Parameter	Symbol Symbol	Wert Value	Einheit Unit
Wellenlänge der Strahlung Wavelength at peak emission $I_F = 100\text{ mA}$	$\lambda_{peak}$	880	nm
Spektrale Bandbreite bei 50% von $I_{max}$ , $I_F = 100\text{ mA}$ Spectral bandwidth at 50% of $I_{max}$	$\Delta\lambda$	80	nm
Abstrahlwinkel Half angle	$\varphi$	$\pm 65$	Grad deg.
Aktive Chipfläche Active chip area	$A$	0.09	mm <sup>2</sup>
Abmessungen der aktiven Chipfläche Dimension of the active chip area	$L \times B$ $L \times W$	$0.3 \times 0.3$	mm <sup>2</sup>
Abstand Chipoberfläche bis Gehäusevorderseite Distance chip front to case surface	$H$	0.4 ... 0.8	mm

**Kennwerte** ( $T_A = 25\text{ °C}$ )  
**Characteristics** (cont'd)

Bezeichnung Parameter	Symbol Symbol	Wert Value	Einheit Unit
Schaltzeiten, $I_e$ von 10% auf 90% und von 90% auf 10%, bei $I_F = 100\text{ mA}$ , $R_L = 50\ \Omega$ Switching times, $I_e$ from 10% to 90% and from 90% to 10%, $I_F = 100\text{ mA}$ , $R_L = 50\ \Omega$	$t_r, t_f$	0.6/0.5	$\mu\text{s}$
Kapazität Capacitance $V_R = 0\text{ V}$ , $f = 1\text{ MHz}$	$C_o$	15	pF
Durchlaßspannung Forward voltage $I_F = 100\text{ mA}$ , $t_p = 20\text{ ms}$ $I_F = 1\text{ A}$ , $t_p = 100\ \mu\text{s}$	$V_F$	1.5 (< 1.8) 3.0 (< 3.8)	V
Sperrstrom Reverse current $V_R = 5\text{ V}$	$I_R$	0.01 ( $\leq 1$ )	$\mu\text{A}$
Gesamtstrahlungsfluß Total radiant flux $I_F = 100\text{ mA}$ , $t_p = 20\text{ ms}$	$\Phi_e$	25	mW
Temperaturkoeffizient von $I_e$ bzw. $\Phi_e$ , $I_F = 100\text{ mA}$ Temperature coefficient of $I_e$ or $\Phi_e$ , $I_F = 100\text{ mA}$	$TC_I$	-0.5	%/K
Temperaturkoeffizient von $V_F$ , $I_F = 100\text{ mA}$ Temperature coefficient of $V_F$ , $I_F = 100\text{ mA}$	$TC_V$	-2	mV/K
Temperaturkoeffizient von $\lambda_{\text{peak}}$ , $I_F = 100\text{ mA}$ Temperature coefficient of $\lambda_{\text{peak}}$ , $I_F = 100\text{ mA}$	$TC_\lambda$	0.25	nm/K

**Strahlstärke  $I_e$  in Achsrichtung**gemessen bei einem Raumwinkel  $\Omega = 0.01$  sr**Radiant Intensity  $I_e$  in Axial Direction**at a solid angle of  $\Omega = 0.01$  sr

Bezeichnung Parameter	Symbol	Wert Value	Einheit Unit
Strahlstärke Radiant intensity $I_F = 100$ mA, $t_p = 20$ ms	$I_e$	> 2	mW/sr
Strahlstärke Radiant intensity $I_F = 1$ A, $t_p = 100$ $\mu$ s	$I_{e \text{ typ.}}$	30	mW/sr

**Relative Spectral Emission**

$I_{rel} = f(\lambda)$

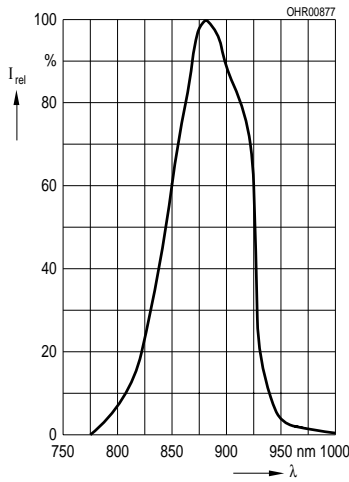

**Radiant Intensity**  $\frac{I_e}{I_e 100 \text{ mA}} = f(I_F)$

Single pulse,  $t_p = 20 \mu\text{s}$

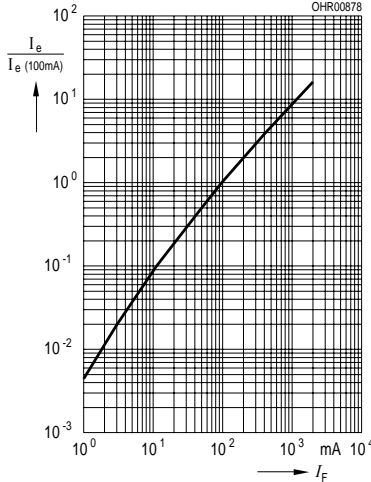

**Max. Permissible Forward Current**

$I_F = f(T_A)$

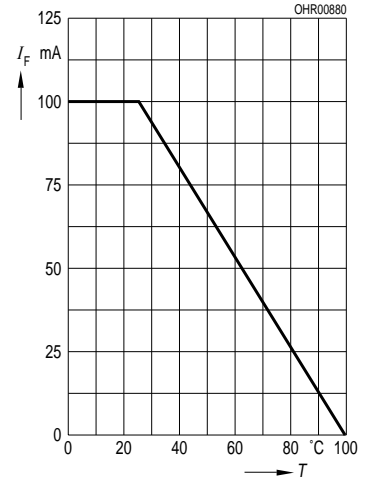

**Forward Current,  $I_F = f(V_F)$**

Single pulse,  $t_p = 20 \mu\text{s}$

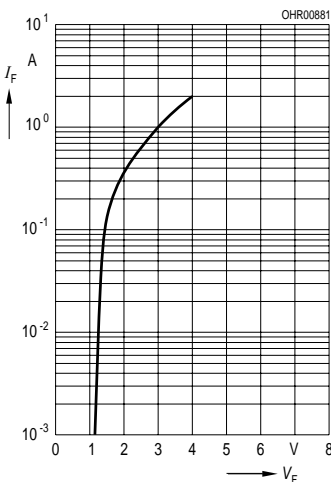

**Permissible Pulse Handling Capability**  $I_F = f(\tau, T_A = 25 \text{ }^\circ\text{C}, \text{duty cycle } D = \text{parameter})$

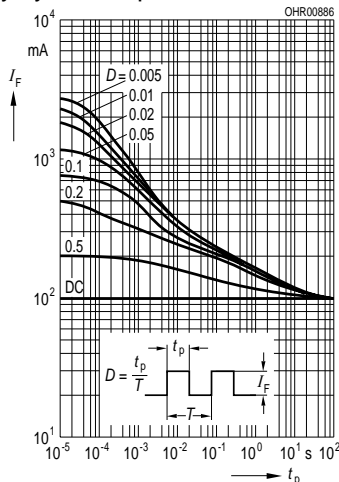

**Forward Current vs. Lead Length between the Package Bottom and the PC-Board**  $I_F = f(l, T_A = 25 \text{ }^\circ\text{C})$

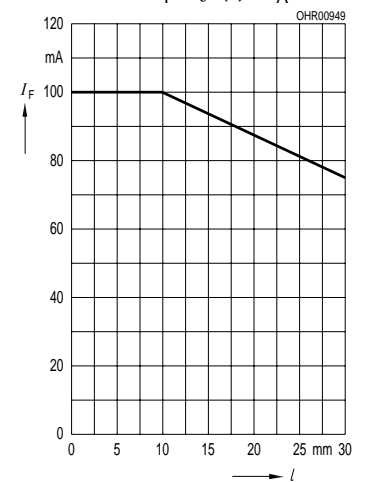

**Radiation Characteristics**  $I_{rel} = f(\varphi)$

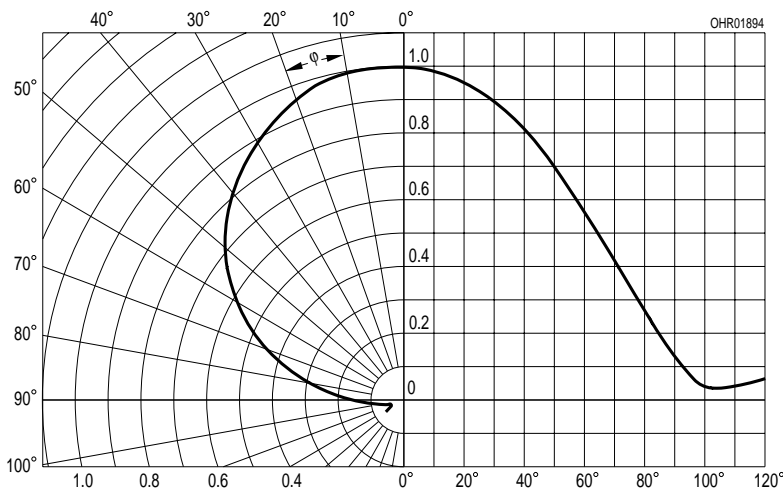

**Maßzeichnung  
Package Outlines**

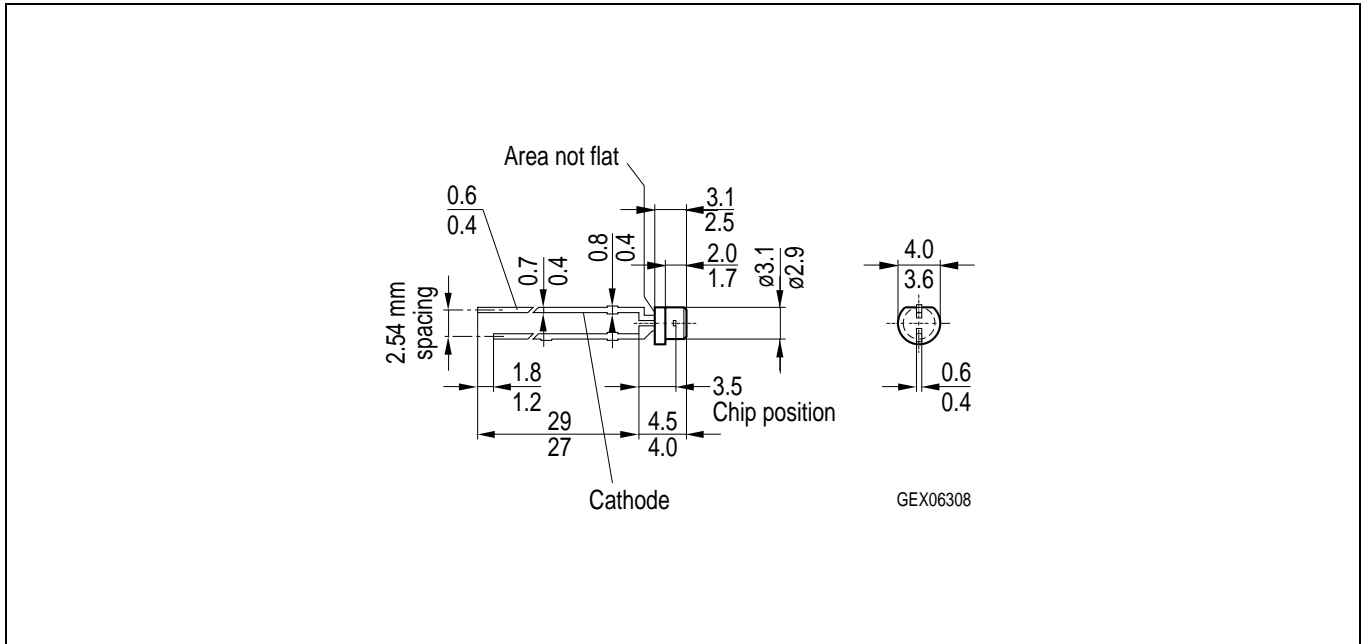

Maße in mm / Dimensions in mm.

**Empfohlenes Lötpaddesign  
Recommended Solder Pad**

Wellenlöten (TTW)  
TTW Soldering

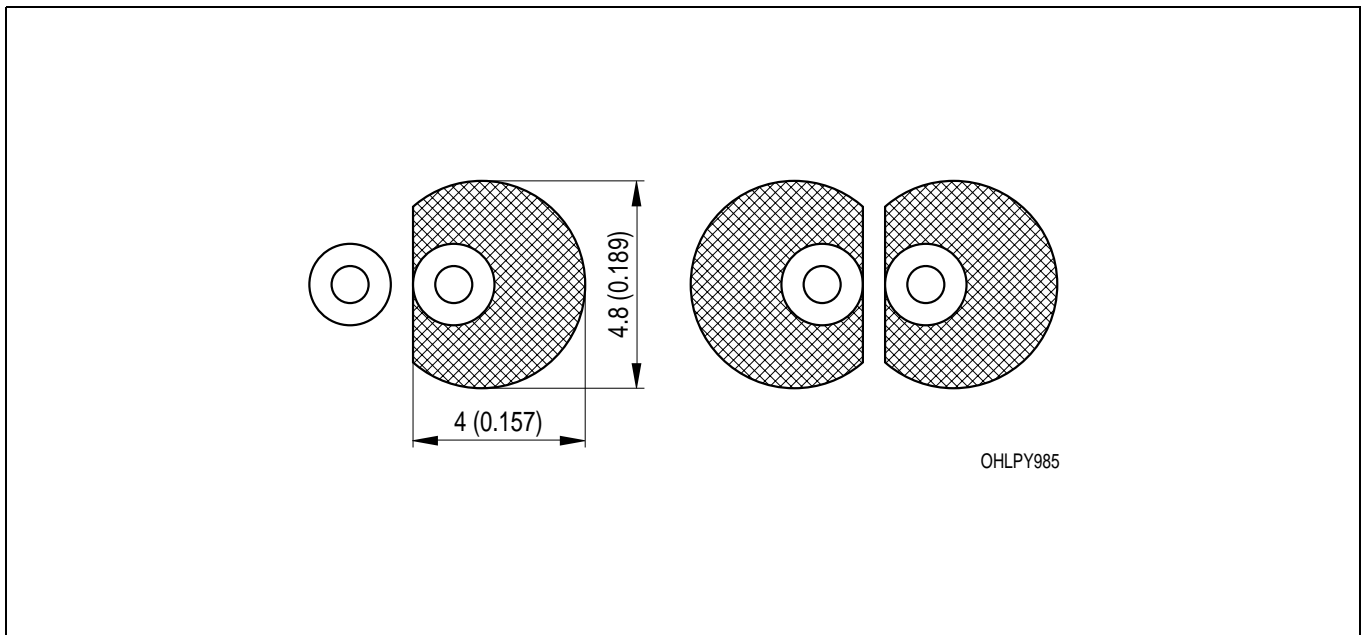

Maße in mm (inch) / Dimensions in mm (inch).

**Lötbedingungen**  
**Soldering Conditions**  
**Wellenlöten (TTW)**  
**TTW Soldering**

(nach CECC 00802)  
(acc. to CECC 00802)

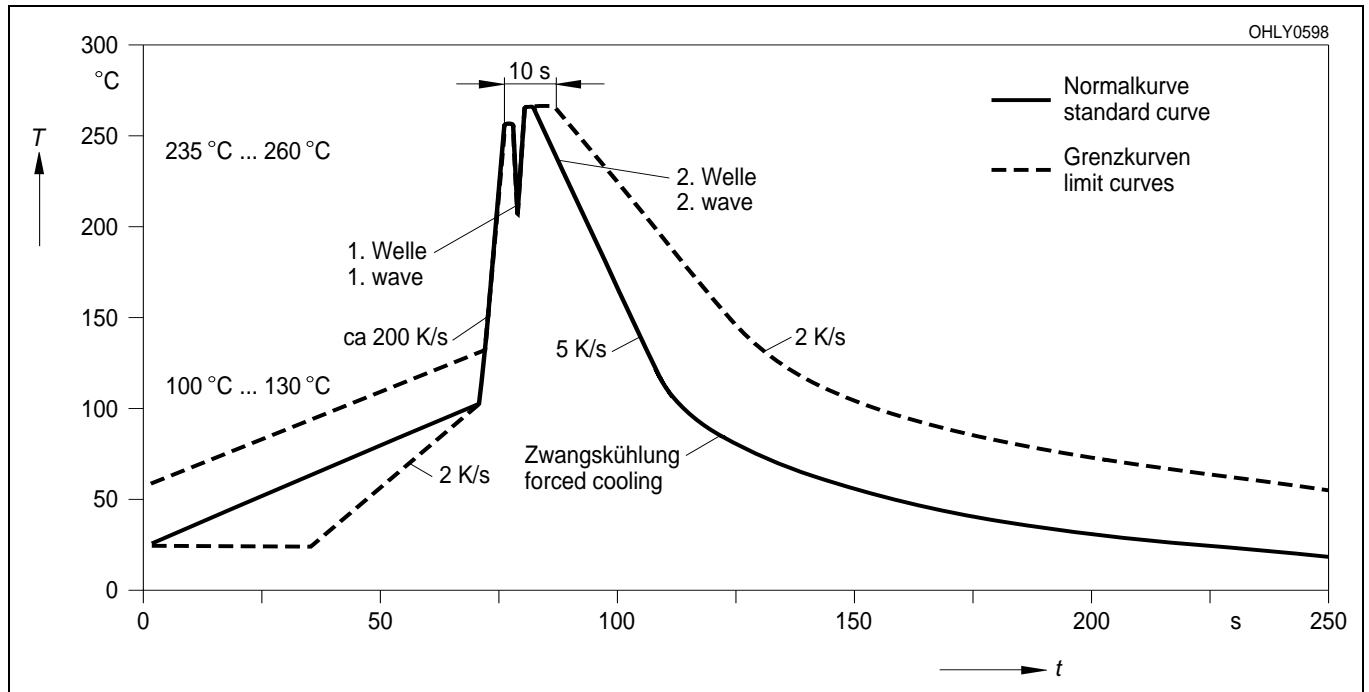

Published by  
**OSRAM Opto Semiconductors GmbH**  
Wernerwerkstrasse 2, D-93049 Regensburg  
[www.osram-os.com](http://www.osram-os.com)  
© All Rights Reserved.

EU RoHS and China RoHS compliant product



此产品符合欧盟 RoHS 指令的要求；

按照中国的相关法规和标准，不含有毒有害物质或元素。

The information describes the type of component and shall not be considered as assured characteristics. Terms of delivery and rights to change design reserved. Due to technical requirements components may contain dangerous substances. For information on the types in question please contact our Sales Organization.

**Packing**

Please use the recycling operators known to you. We can also help you – get in touch with your nearest sales office. By agreement we will take packing material back, if it is sorted. You must bear the costs of transport. For packing material that is returned to us unsorted or which we are not obliged to accept, we shall have to invoice you for any costs incurred.

**Components used in life-support devices or systems must be expressly authorized for such purpose!** Critical components<sup>1</sup>, may only be used in life-support devices or systems<sup>2</sup> with the express written approval of OSRAM OS.

<sup>1</sup> A critical component is a component used in a life-support device or system whose failure can reasonably be expected to cause the failure of that life-support device or system, or to affect its safety or effectiveness of that device or system.

<sup>2</sup> Life support devices or systems are intended (a) to be implanted in the human body, or (b) to support and/or maintain and sustain human life. If they fail, it is reasonable to assume that the health of the user may be endangered.

# Mouser Electronics

Related Product Links

[720-SFH487P - Osram Opto Semiconductor SFH 487 P](#)